

规格书

WWT230-07-95

6M 工业镜头

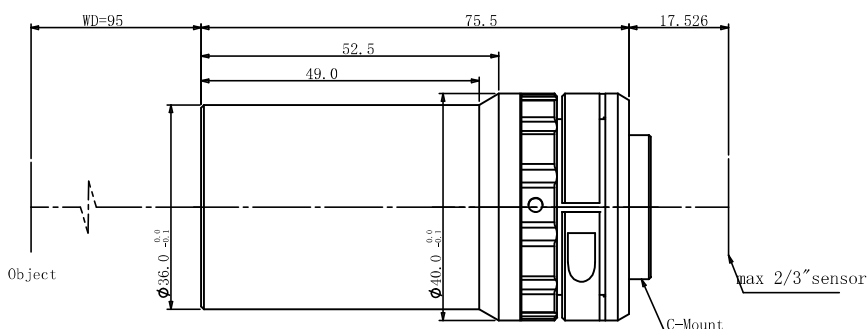

光学参数

放大倍率 β (x)	0.7
物方工作距 WD (mm)	95
支持 CCD 尺寸 (Φ mm)	11.0(2/3")
像方 F/#	7.5
焦距 (mm)	45.48
数值孔径 NA	0.04663
物方分辨率 (μ m)	7.2
物方景深 DoF (mm)	1.2
像方 MTF30 (lp/mm)	96
TV 畸变 (%)	-0.0268

视野范围 (mm × mm)

1/1.8" (7.13x5.37)	10.2x7.7
1/1.8" (7.43x4.9)	10.6x7
2/3" (8.45x7.1)	12.07x10.14

机械参数

相机接口	C
镜头总长 (mm)	75.5
是否同轴光 / 可调光栏	否 / 否

